

MADE IN FRANCE

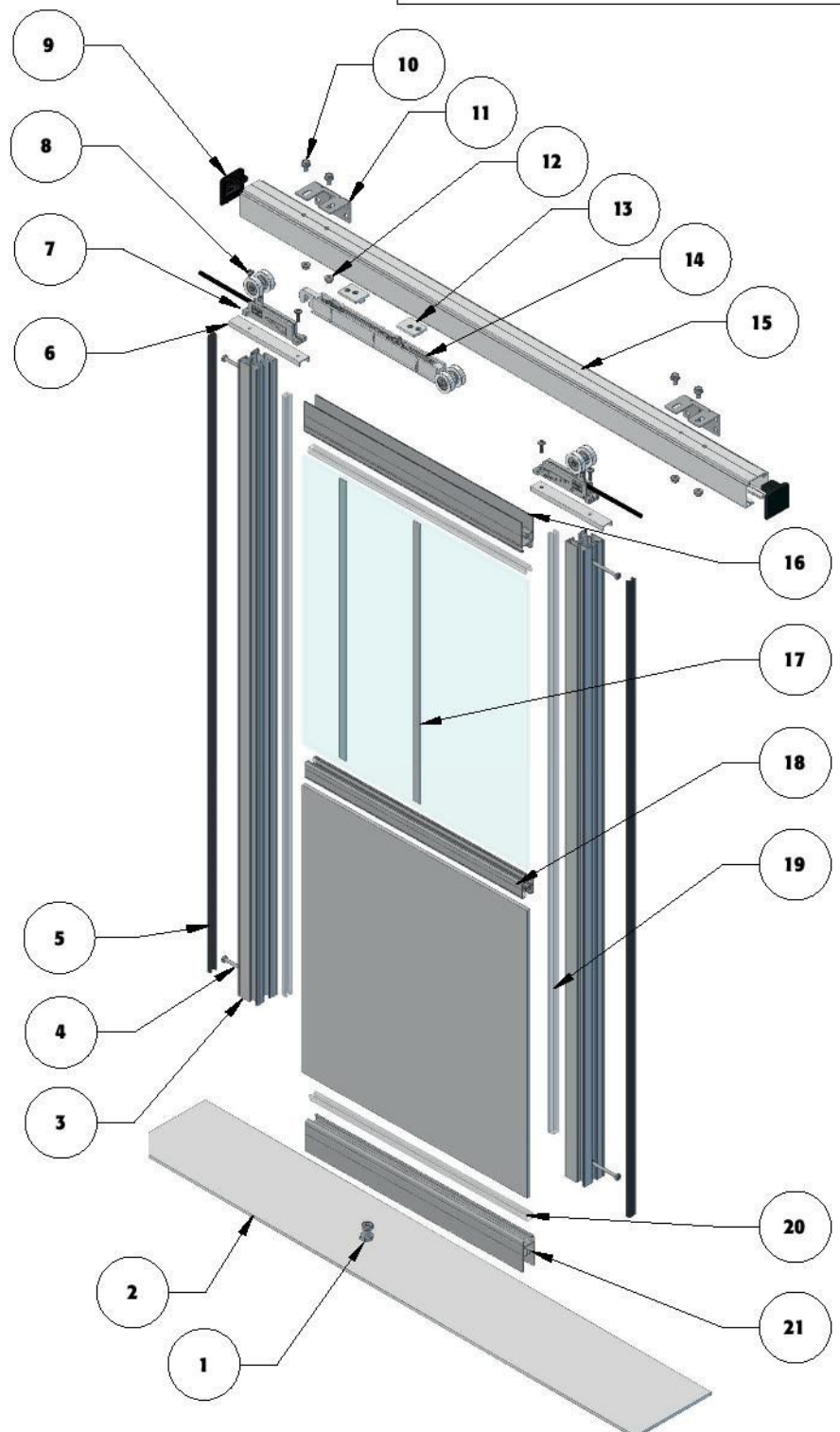
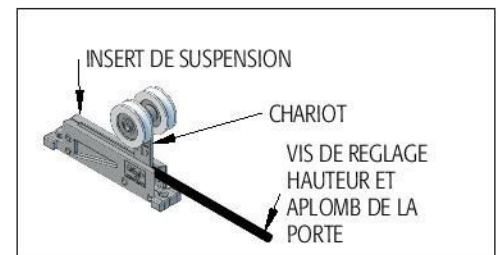
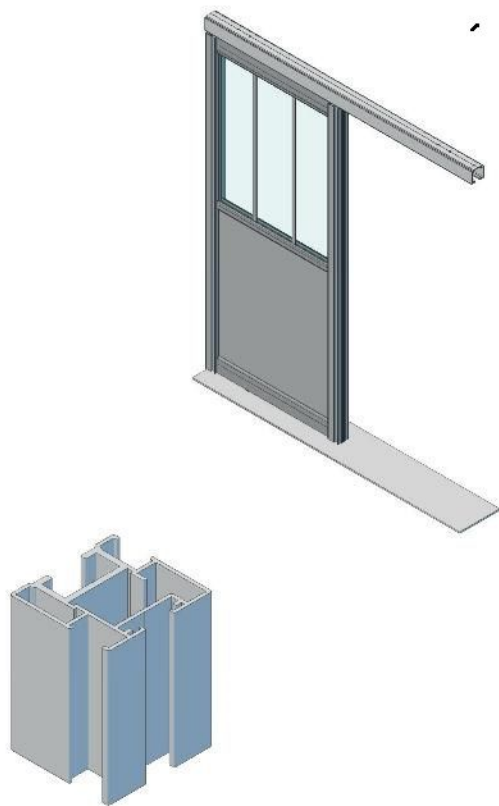

N°	Qté	Nom de la pièce	
1	1	Guide bas	GUIDBAS
2	1	Sol	
3	2	Poignée P810	P810
4	4	Vis d'assemblage 4.8x40	VIS4.8*40
5	2	Joint de finition	JBUT
6	2	Insert fixation chariot	INSERTFIXCHAR40
7	2	Chariot 40 KG	CHARIOT40N
8	4	Vis 5x20	vis5*20
9	2	Capot rail 40 KG	CAPOT40
10	4	Vis M5x10	VIS5*10
11	2	Equerre suspension rail	EQUERRESUSP
12	4	Ecrou M5	ECROUM5
13	2	Activateur frein amortisseur	ACTIVFR40
14	1	Frein amortisseur	FR40-D
15	1	Rail haut 40 KG	RHS43
16	1	Traverse haute 52	THB52
17	4	Plat à coller 25 mm	PLAT25
18	1	Traverse intermédiaire 28	TI28
19	2	Joint de vitrage	PVITRAGE
20	4	Joint de vitrage	PVITRAGE
21	1	Traverse basse 52	THB52

Notice de montage

ÉTAPE 1 : Positionnement des inserts (fixation chariot)

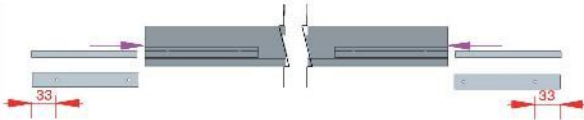

ÉTAPE 2 : Mettre l'extrémité de l'insert contre la traverse

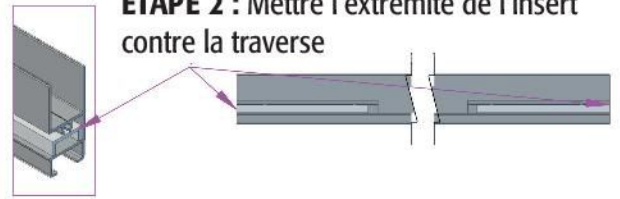

ÉTAPE 3 : Positionnement des chariots

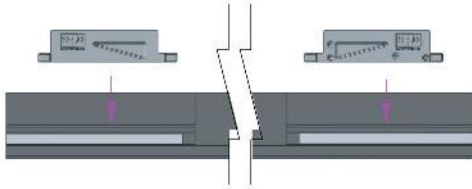

ÉTAPE 4 : Visser le chariot et l'insert avec la vis 5X20

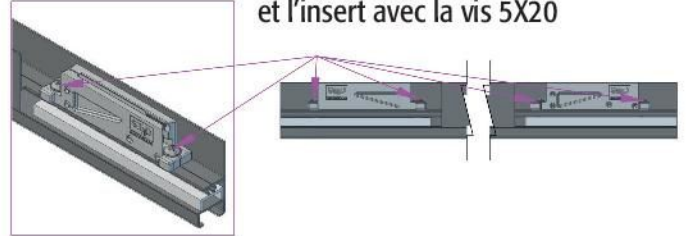

ÉTAPE 5 : Positionner les traverses haute et basse

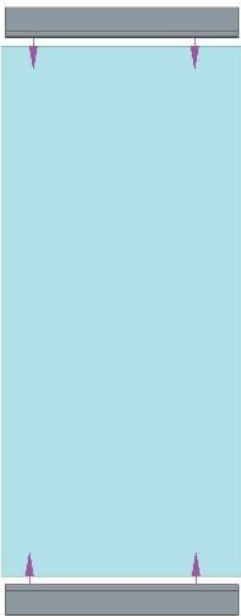

ÉTAPE 6 : Assembler les traverses et le remplissage

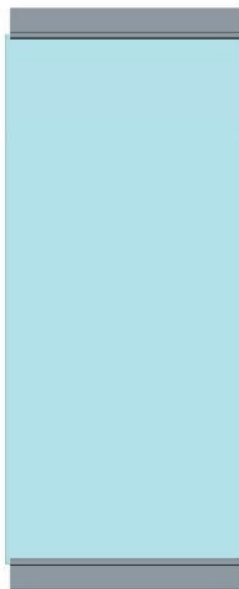

ÉTAPE 7 : Positionner les profils poignées

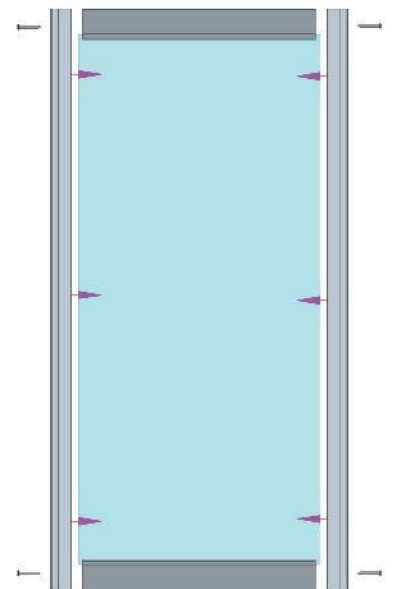

ÉTAPE 8 : Assembler les profils poignées et le remplissage

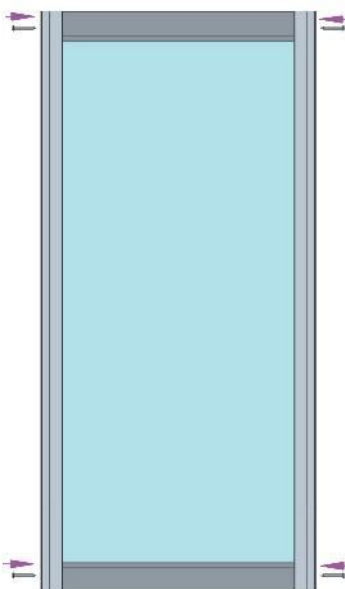

ÉTAPE 9 : Visser les profils poignées et les traverses avec la vis 4.8X41

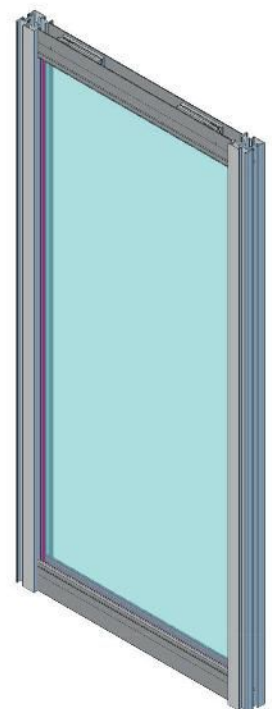
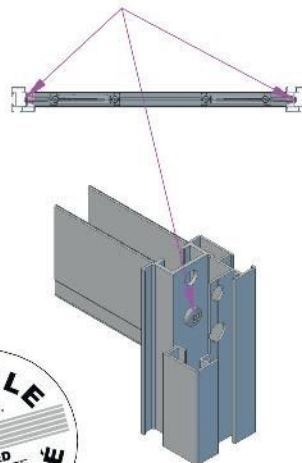

Notice de montage

Fixation du rail

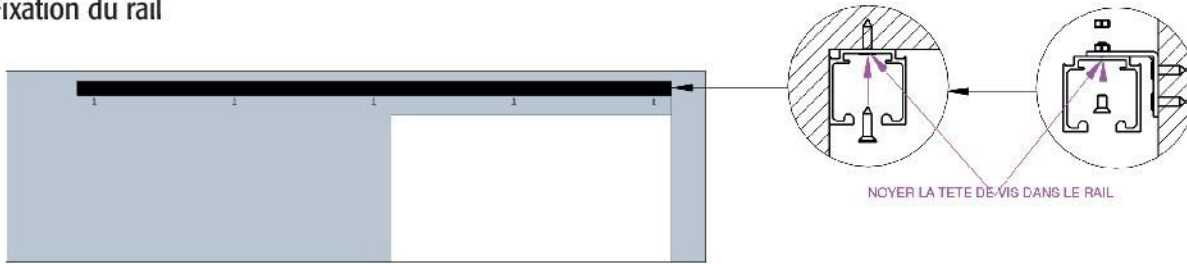

Mise en place chariot, activateur et frein



Mise en place du doigt de guidage

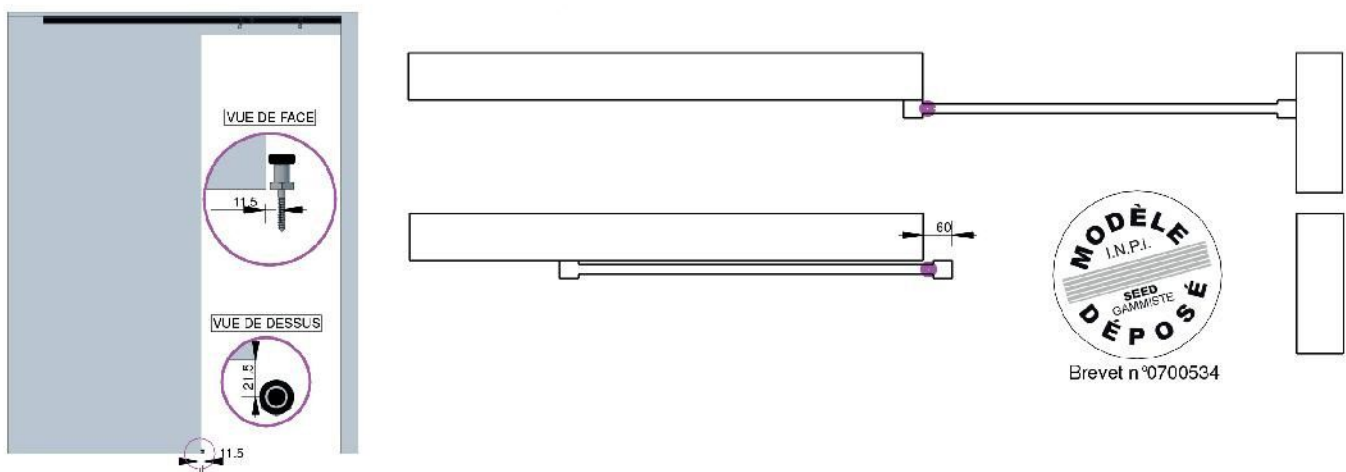

Pour un ouverture complète de la porte, vous pouvez faire un grugage dans la partie basse de la poignée. (voir schéma)

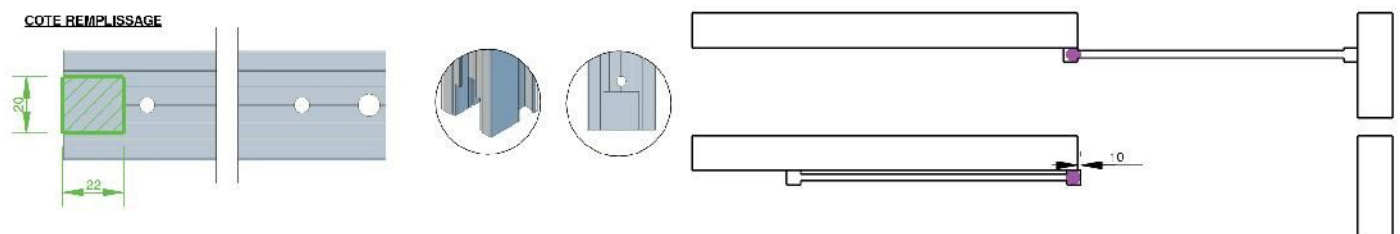

Notice de montage



ÉTAPE 1 : Positionner la porte avec la traverse basse dans le guide bas



ÉTAPE 2 : Positionner la porte sous le rail



ÉTAPE 3 : Prendre un tournevis plat, puis l'insérer dans la fente



ÉTAPE 4 : Ammener le chariot dans l'insert de suspension

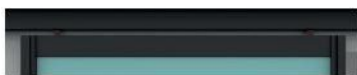

ÉTAPE 5 : Idem etape 4, mais de l'autre coté.



ÉTAPE 6 : Approcher les vis de réglage du chariot



ÉTAPE 7 : Prendre un tournevis six pans (empreinte 3 mm) puis visser pour monter la porte

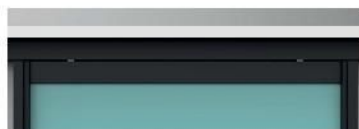

ÉTAPE 8 : Régler la porte à la hauteur voulu



ÉTAPE 9 : Insérer les joints plats de finition dans la rainure du profil



ÉTAPE 10 : Mise en place du capot de finition noir

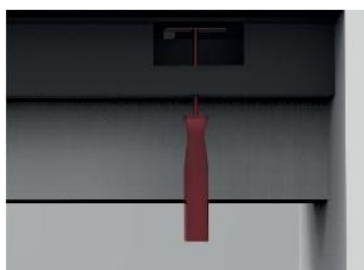

ÉTAPE 11 : Réglage des activateurs

rail haut

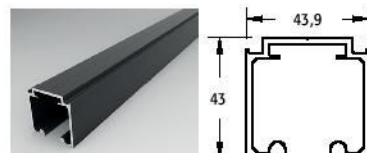

poignée

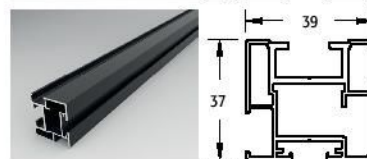

traverse haute et basse 52

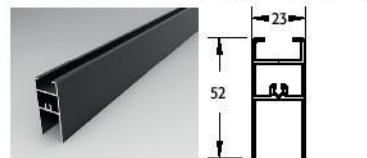

traverse intermédiaire 28

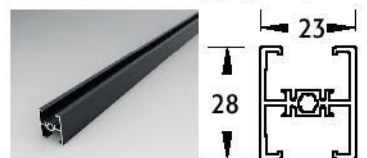

joint de vitrage 6 à 8 et 10 à 12

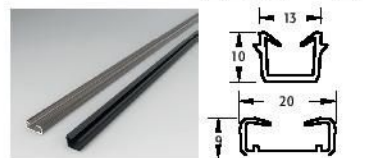

joint de finition

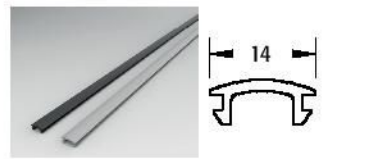

chariot 40 kg N

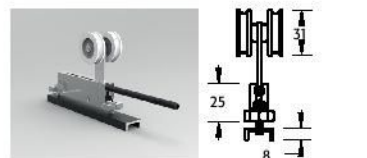

frein amortisseur + activateur



capot rail 40 kg

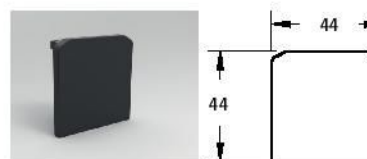

guide bas

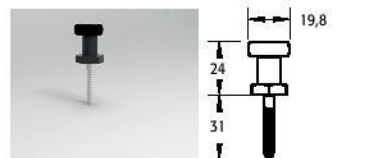

équerre suspension

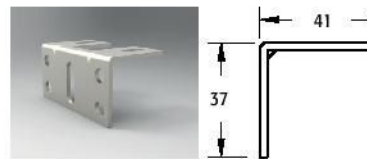

montage frein amortisseur avec le chariot

